

INSTALLATION OF PARALUME / "CC" COMPACT CUBE  
1x1 FLOURESCENT FIXTURE

READ AND UNDERSTAND THESE INSTRUCTIONS BEFORE INSTALLING FIXTURE

This fixture is intended for installation in accordance with the National Electrical Code and local regulations. To assure full compliance with local codes and regulations; check with your local electrical inspector before installation. To prevent electrical shock, turn off electricity at fuse box before proceeding. This fixture is suitable for damp locations.  
RETAIN THESE INSTRUCTIONS FOR MAINTENANCE REFERENCE.

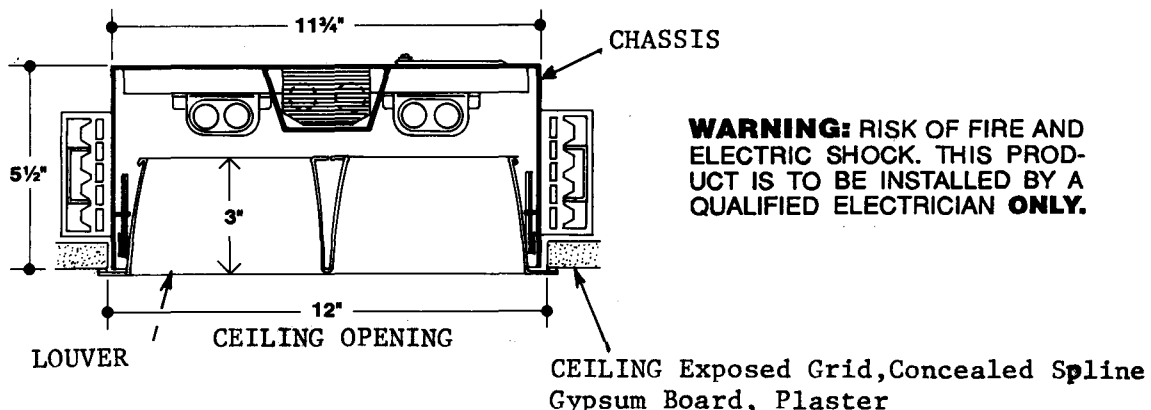

A. INSTALL FIXTURE USING ADJUSTABLE MOUNTING BRACKET

Install CHASSIS before CEILING is finished.

- a. With MOUNTING BAR (order seperately) 18"-Cat. No. MB18  
27" Cat. No. MB27, using rectangular slots as shown

- b. With 3/4" CHANNEL (by others)

- c. With 1 1/2" CHANNEL (by others)

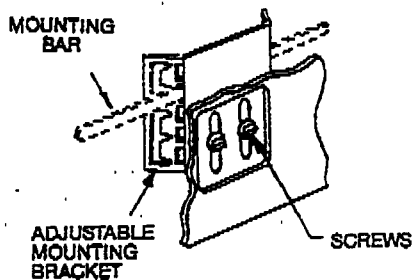

FIG. 2

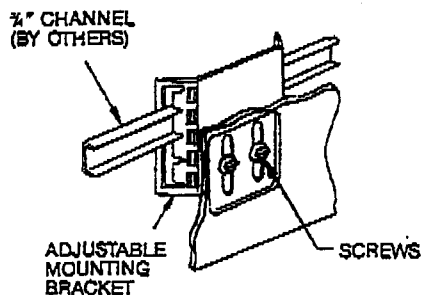

FIG. 3

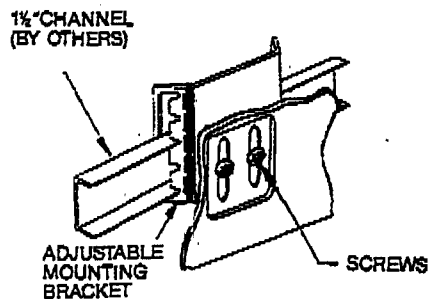

FIG. 4

B. ADJUST CHASSIS

For installation in both dry ceilings and plaster, CHASSIS must be set so that the bottom edge is flush with the finished ceiling, as shown on Fig. 5.

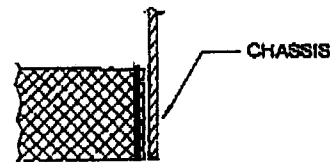

FIG. 5

- NOTE: 1. Final vertical adjustment can be made by means of MOUNTING BRACKET SCREWS (Fig.2) on side of CHASSIS.  
2. To insure proper installation, it is important that the CHASSIS always be secured to structural ceilings members .

**C. WIRING**

**WARNING: TO AVOID A POTENTIAL ELECTRICAL SHOCK, BE SURE CIRCUIT IS SWITCHED OFF BEFORE PROCEEDING.**

1. Remove access plate and attach flexible conduit containing supply leads and ground wire (Fig. 6)
2. Make wiring connections. Observe wiring polarity, white to white, black to black and green (or bare lead) to ground screw provided on access plate.
3. Tuck wiring into CHASSIS.
4. Insert tab on access plate into one end of opening and fasten other end with fastening screw.

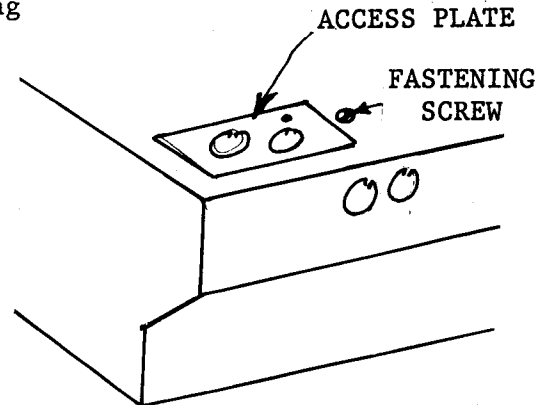

FIG. 6

**D. INSTALLATION AND REMOVAL OF LOUVER AND DIFFUSER**

1. Squeeze torsion springs and insert into slots in hinge rail.
2. Push louver up into fixture till seated against ceiling surface. (Fig. 7).
3. To remove, grasp louver firmly by edges and pull straight down. (Fig.7).

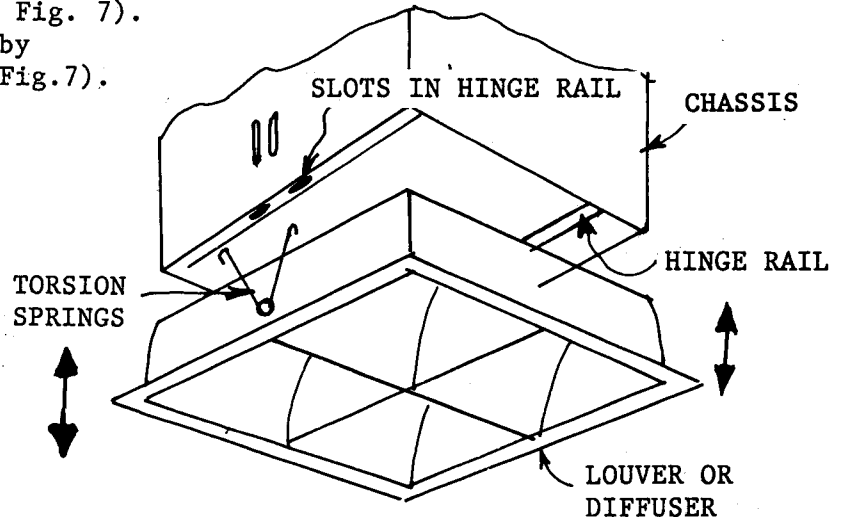

FIG. 7

**MAINTENANCE OF LOUVER**

Do not handle optical surfaces with bare hands. To avoid fingerprints handle LOUVERS only by the outside surfaces or with clean cotton gloves.

**TO CLEAN LOUVERS:**

1. Wipe with a clean, dry, lint free cloth or,
2. Wipe with a clean cloth dampened with a solution of mild detergent (2½ oz. per gallon of water). Then wipe dry.