

NEW SHALLOWER DESIGN HOSPITAL PATIENT ROOM LIGHT

Series **562HPR**

FEATURES

- NEW SHALLOWER DESIGN.
- COST EFFECTIVE HOSPITAL PATIENT ROOM LIGHT.
- SINGULAR 2x4 RECESS MODULE FOR EASE OF INSTALLATION.
- MULTI-TASK FUNCTIONAL LIGHTING SYSTEM:
 - * Patient Reading Light
 - * Ambient Soft Glare Free Lighting
 - * Examination Light Extra High Efficiency
 - * Night Light Option
- SEPARATE CIRCUITING FOR MULTI CONTROL
- CAD/CAM ENGINEERED PRECISION MANUFACTURED.
- MANY OPTIONAL SHIELDINGS AVAILABLE.

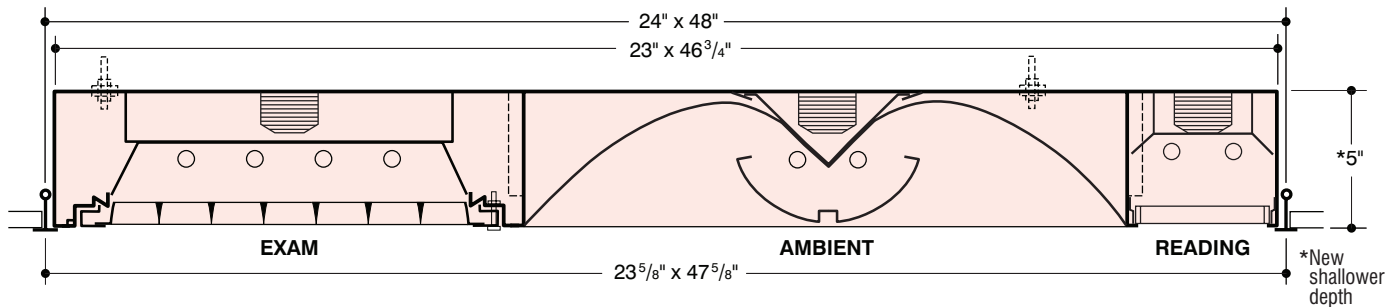
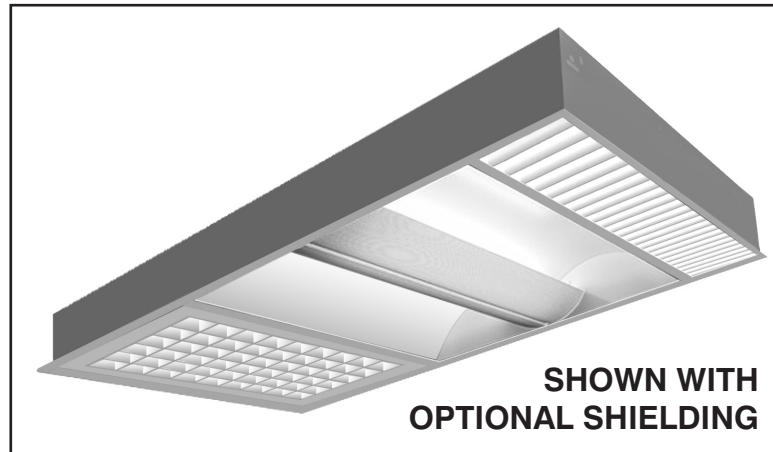

SPECIFICATIONS

CONSTRUCTION: Die formed of 20 gauge cold rolled steel, rigidly fabricated. and electrically welded to insure true and perfect alignment.

REFLECTOR: Ambient and Exam sections, code gauge cold rolled steel, CAD designed for optimum lighting control, finished in white. Reading section, CAD designed for optimum efficiency. All are removable to access wiring.

SHIELDING: *Exam section* – 18 gauge cold rolled steel door, electrically welded with concealed weld gussets at corner joints for rigidity, with exclusive "LIGHT-LOCK"™ design for light tight fit to housing. Hinges from either side on 16 gauge Tee Slot Hinges and secured with knurled screws for easy relamping and supplied standard with Low Brightness Acrylic Refractor. *Ambient Section* – supplied standard with swing down perforated metal with white acrylic overlay, finished white. *Reading Section* – supplied standard with tip tilt Low Brightness Prismatic Acrylic Refractor. Other shieldings available for all Sections (see OPTIONS and consult factory).

ELECTRICAL: Electronic Programmed Start 14W T5, 24W T5HO, 270MA Biax, Twin Tube, High Power Factor, Class A sound rated, U.L., CSA, FCC Listed Type 1 for multi-volt operation. Other voltages and frequencies available, CONSULT FACTORY.

MOUNTING: Designed to integrate into most standard lay-in grid and Fineline ceilings. Unit rests on the flanges of the exposed tee. Knockouts are provided on back and ends for feed and thru wiring. **Fixture must be independently supported from the suspended ceiling (rod support suggested).**

FINISH: All steel component parts are completely protected

against rust and discoloration after fabrication through an automated conveyerized multi-stage phosphate bonding process. Finished with an electrostatic baked white polyester thermosetting powder coating. This electronic computer controlled integrated system assures consistent high reflectance efficiency and maximum durability. Available OxyShield and OxyGuard 2 stage process, (see OPTIONS). Visit our website for details.

CERTIFICATION: The Hospital Patient Room Light Series 562HPR is U.L. and C.U.L. listed and bears the label of the I.B.E.W./AFL-CIO, Local #3.

LIGHT-LOCK™ is a trademark of LEGION LIGHTING CO., INC.
LEGION® is a registered trademark of LEGION LIGHTING CO., INC.

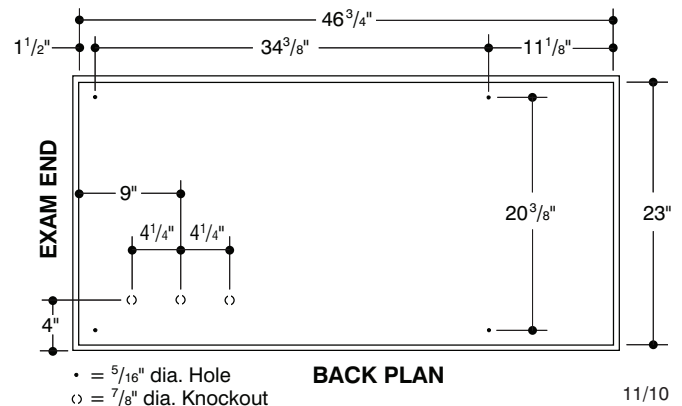

Series 562HPR

New Shallower Design Hospital Patient Room Light

ORDERING DATA

Catalog No.		No. and Type Lamps	Weight	Nominal Size
T5	562-814-RFA	8-F14T5	75 lbs	2' x 4'
	562-824HO-RFA	8-F24HOT5		
BIAX	562-6BX40-RFA	*6-F40TT/RS	80 lbs	
	562-6BX50-RFA	*6-F50TT/RS		
	562-6BX55-RFA	*6-F55TT/RS		

*F40TT/RS, F50TT/RS and F55TT/RS is the ANSI designation of various lamp manufacturers, i.e.: G.E. Lighting "BIAX", Phillips "PL", Osram "Dulux L", Sylvania "Twin Tube".

OPTIONS

- ** Suffix "WH" after catalog no. for White Finish on louver.
- ** Suffix "SPS" after catalog no. for Specular Silver finish on louver.
- ** Consult factory for Minimum Quantity Order.

ELECTRONIC

"EBX"-Electronic (BIAX) Twin Tube Ballast
 "EBDX"-Electronic (BIAX) Twin Tube Dimming Ballast – Consult Factory for Dimming Options.

Legion is a Lutron® Silver Partner

Lutron® is a registered trademark of Lutron Electronics.

SPECIFY ORDERING FROM DATA BELOW

Mounting	Series	Lamp Type	Reading Section		Ambient Section		Exam Section		Voltage	Options
			# of Lamps	Diffuser	# of Lamps	Diffuser	# of Lamps	Diffuser		
	562									
Blank (Surface) J (Grid) F (Flange)		F14-T5 F24-T5HO BX40 BX50	1 or 2 (F14-T5) 1 or 2 (F24-T5HO) 1 only (BX40) 1 only (BX50)	R (RFA) K (K19A) F (FA) P (PWA) L (LB)	1,2 or 3 (F14-T5) 1,2 or 3 (F24-T5HO) 1 or 2 (BX40) 1 or 2 (BX50)	PS (PERF) LB (PSLB) LS (PSLS)	3 or 4 (F14-T5) 3 or 4 (F24-T5HO) 3 or 4 (BX40) 3 or 4 (BX50)	R (RFA) K (K19A) F (FA) P (PWA) A (AL) AP (AP54)	1 (120V) 2 (277V) U (UNV)	SQR (Low Voltage electronic sequential switching relay) OX (OxyShield/OxyGuard anti bacterial coating) FILT (Radio Interference filter) NL/PL (Night light for PL fluorescent lamp) EM (Emergency battery pack)

CEILINGS

- ++ Type (J) Exposed inverted "T" ceiling.
- ++ Type (J) Concealed inverted "T" ceiling.
- ++ Type (J) Exposed inverted "T", Tegular ceiling.
- ++ Type (J) Exposed inverted "T", Fineline ceiling.
- ++ (J) Exposed troffers. The corners of the ceiling opening should be well supported to withstand the weight of the troffer.

CONSULT FACTORY FOR FLANGED AND SURFACE MOUNTING.

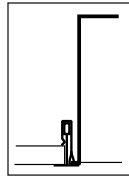

EXPOSED
"T" BAR
Type "J"
Lay-In

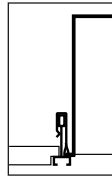

FINE LINE
Type "J"
Lay-In

PHOTOMETRIC DATA

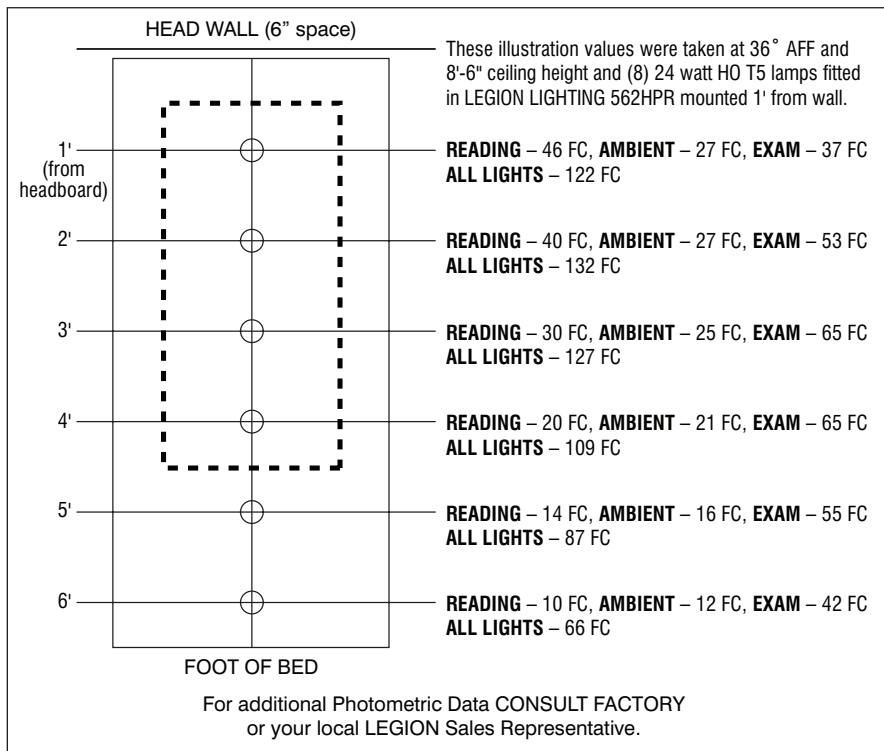

PATIENT READING LIGHT

Enables patients to read without disturbing others. No direct glare to patient or visitors.

EXAMINATION LIGHT

Illumination over the entire bed for the doctors and nurses examinations.

AMBIENT LIGHT

Soft light provides glare free illumination to the whole patient room environment.

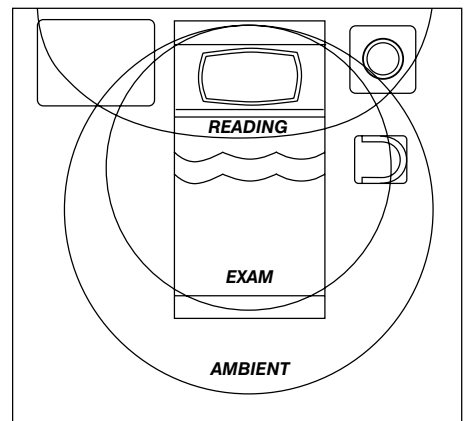

Information supplied primarily for illustrative purposes, subject to change. Consult factory for verification and minimum quantity orders.